

# INSTRUKCJA MONTAŻU

INSTALLATION INSTRUCTIONS, MONTAGEANLEITUNG

## Zestaw R3-Steps-REG2

**PL** • Zalecamy nie wyrzucać opakowania dopóki nie ukończysz montażu. • Montażu najlepiej dokonać na miękkiej i czystej powierzchni, takiej jak tektura, ręcznik, koc. Uchroni to przed uszkodzeniem krawędzi mebla. • Po złożeniu stołów oraz biurek nie przenosimy za blat. • Nie montować elementów jeśli zauważysz wady lub uszkodzenia. **EN** • We recommend that you do not throw away the packaging until you have finished the assembly. • Installation is best done on a soft and clean surface, such as a cardboard, towel or blanket. This will prevent any damage to the edge of the furniture. • After assembling the tables and desks, do not lift them by the table top. • Do not install the elements if you notice any defects or damage. **DE** • Wir empfehlen die Verpackung nicht wegzuerfen bis die Montage nicht abgeschlossen ist. • Montieren Sie es am besten auf einer weichen und sauberen Oberfläche wie Pappe, Handtuch, Decke. Die Möbelkanten werden gegen Beschädigung geschützt. • Beim Tragen der Tischen und Schreibtischen greifen Sie nicht nach der Tischplatte. • Montieren Sie keine Elemente, wenn Sie Mängel oder Beschädigungen feststellen.

balma

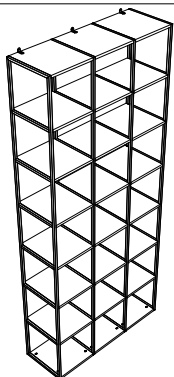

Okucia, Möbelbeschläge, fittings

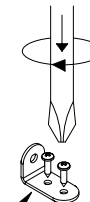
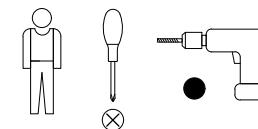
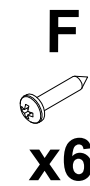
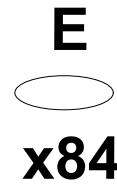
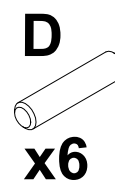
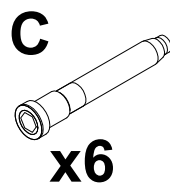
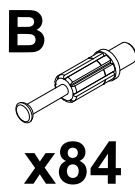

5

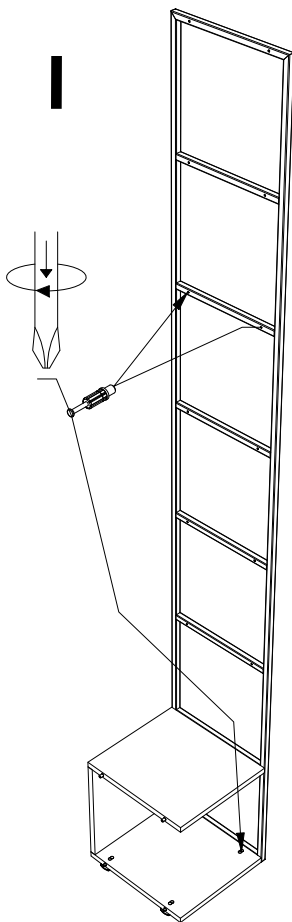
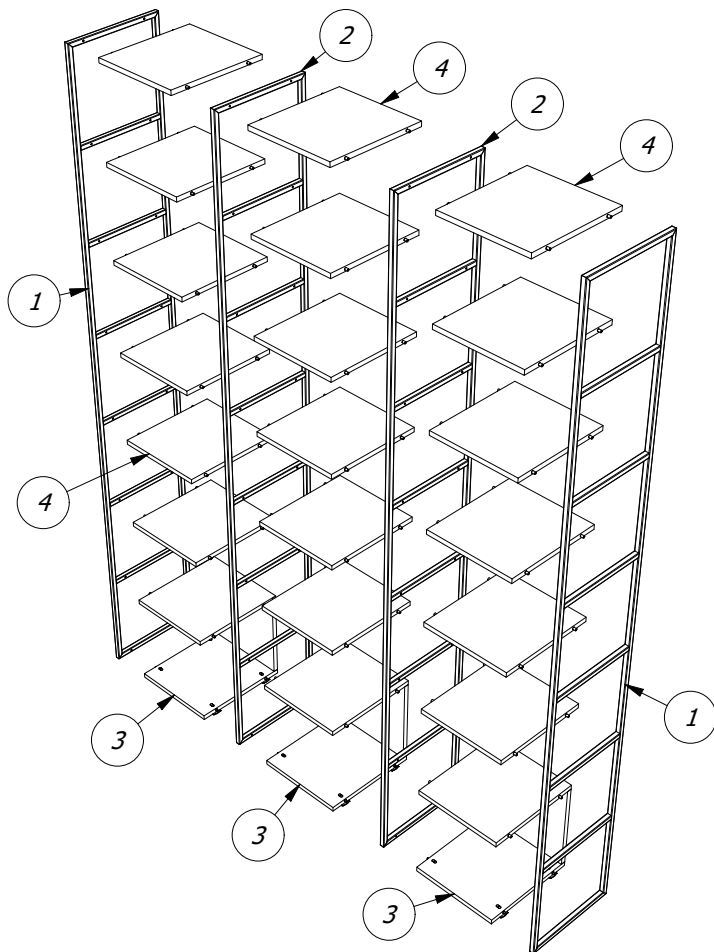

Nr	NUMER CZĘŚCI	L szt.
1	R3-107	2
2	R3-127	2
3	R3-157	3
4	R3-154	18
5	R3-171	3

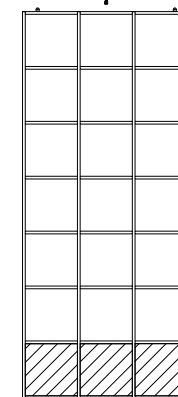

II

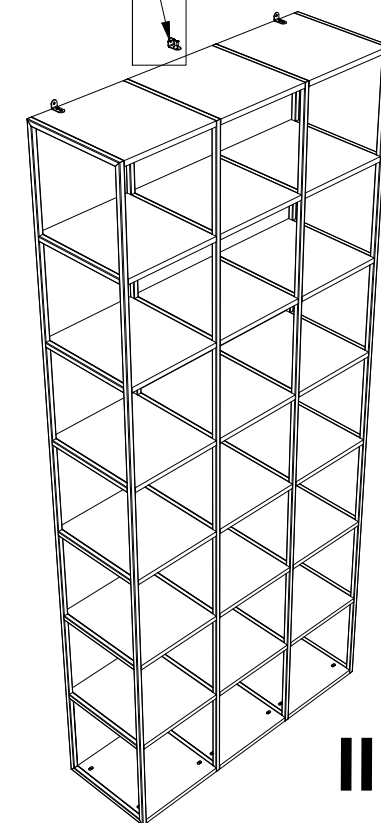
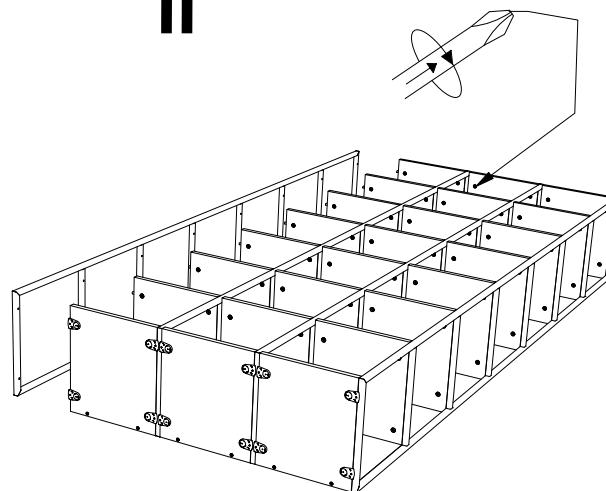

III